



# PLUS<sup>+</sup> SHADE OPEN ROLL MANUAL

## INSTALLATION INSTRUCTIONS

Rollashade.com  
info@rollashade.com  
951.245.5077

© Copyright Roll-A-Shade® Inc. All Rights Reserved.



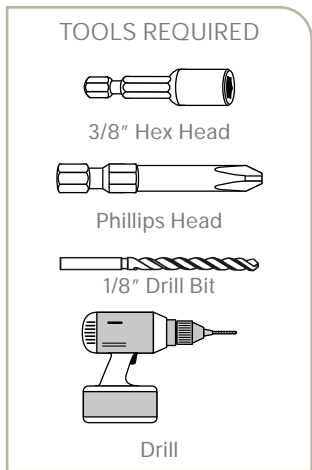
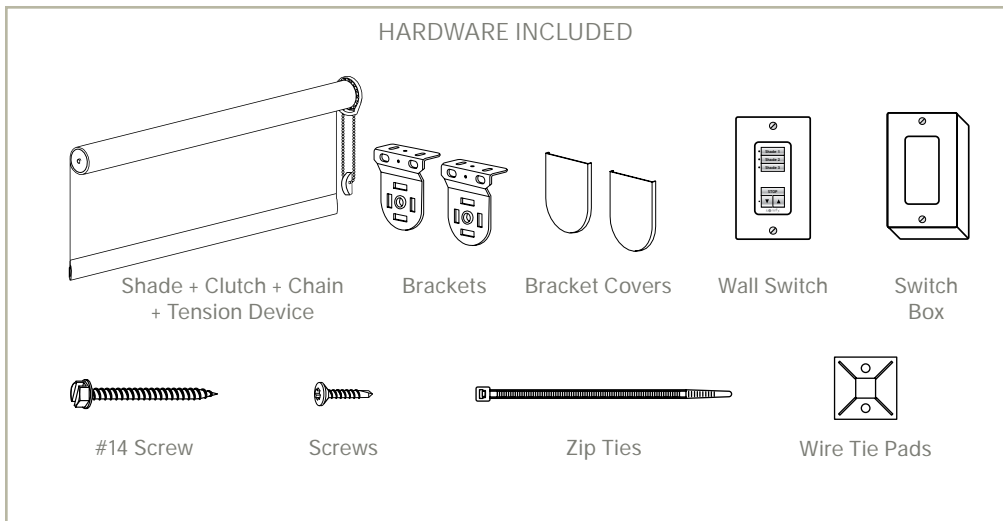

**1 INSIDE OR OUTSIDE APPLICATION**

**\*\*NOTE: ALL SHADES MAY BE PRE-PROGRAMMED TO SENSORS, REMOTES, AND/OR WALL SWITCHES UPON ARRIVAL\*\***

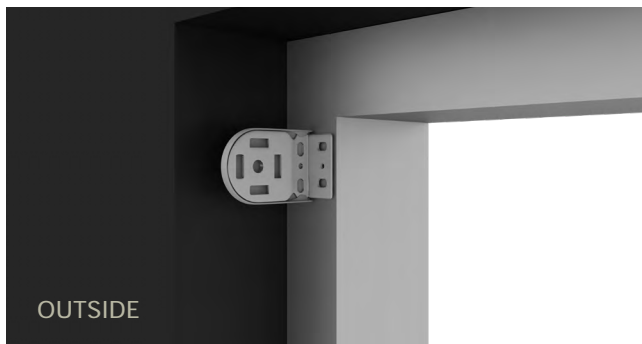
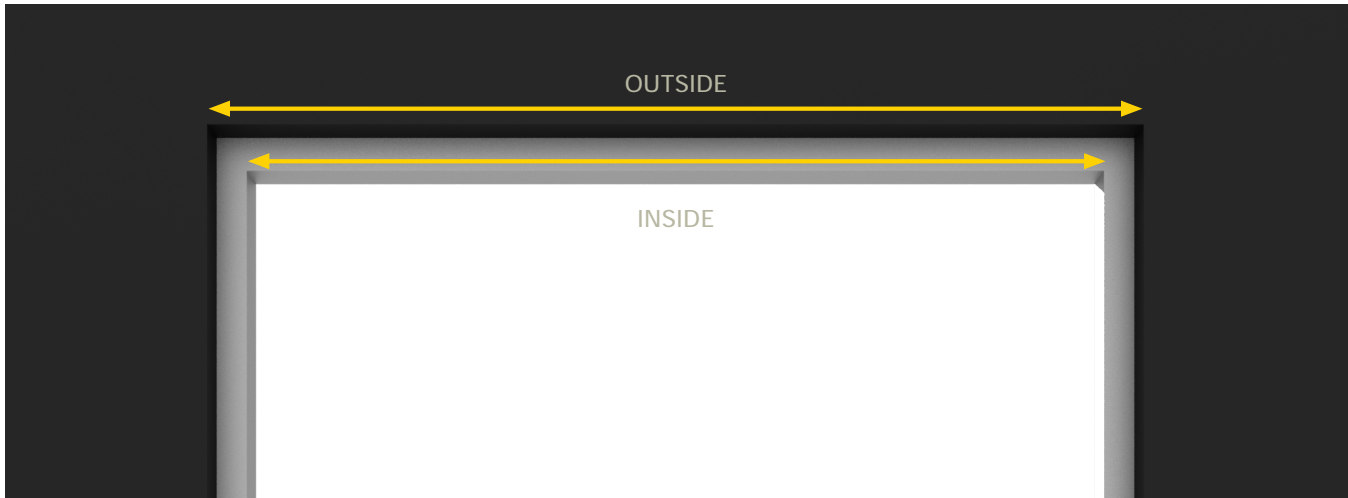

## 2 MOUNTING LOCATION

Place your first bracket in its mounting location and mark the screw holes. Place your second bracket in its mounting location and repeat the process.

A.



B.

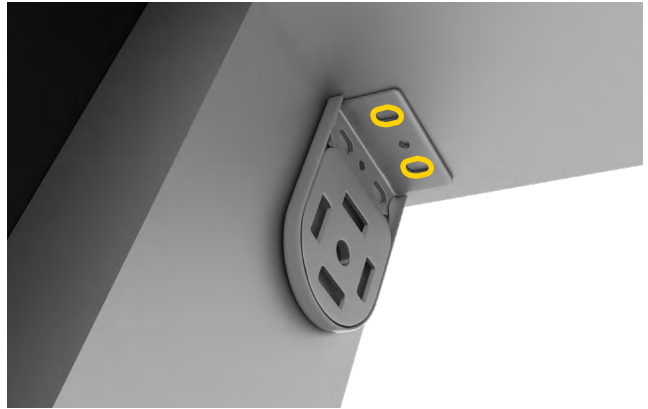

C.



## 3 SCREW INSTALLATION

Next, pre-drill your screw holes using a 1/8" drill bit. Install the brackets with the provided screws using the 1/4" hex head driver.

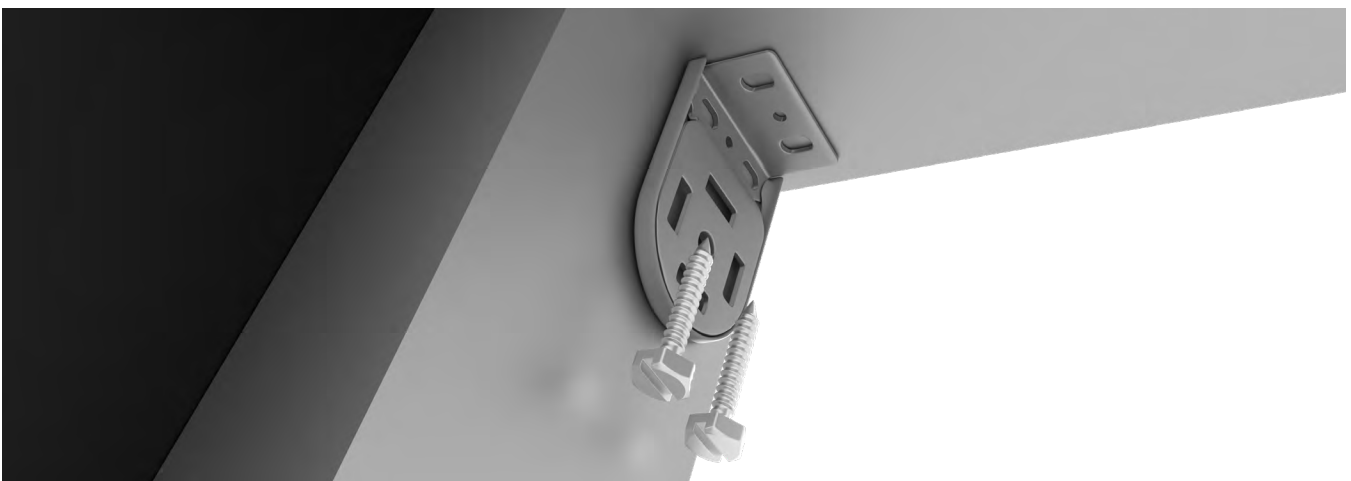

#### 4 ALIGNMENT

Check to make sure your brackets are level and aligned.

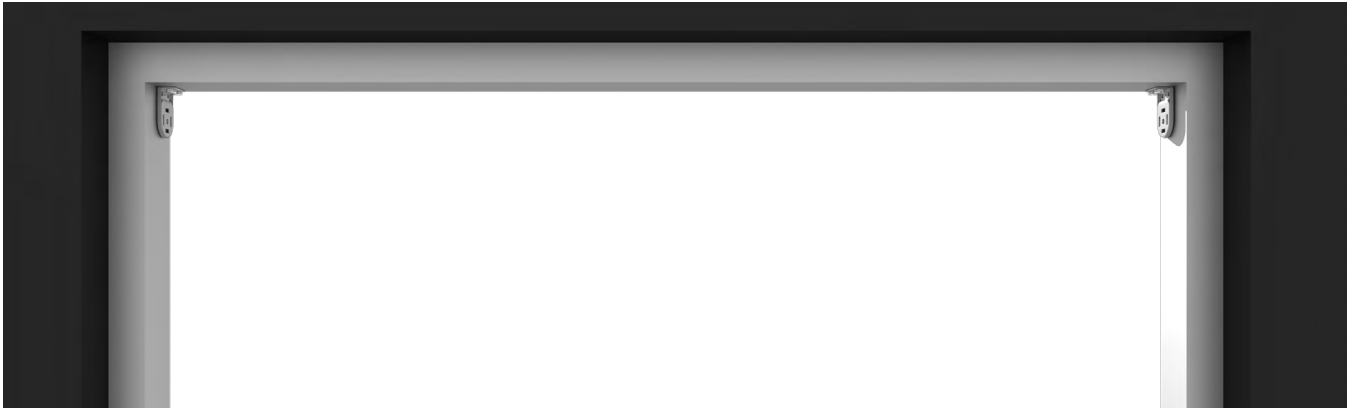

#### 5 SHADE PIN END INSTALLATION

Depress pin end and slide onto bracket until pin engages in center hole. Press idler shaft all the way to the bracket.

A

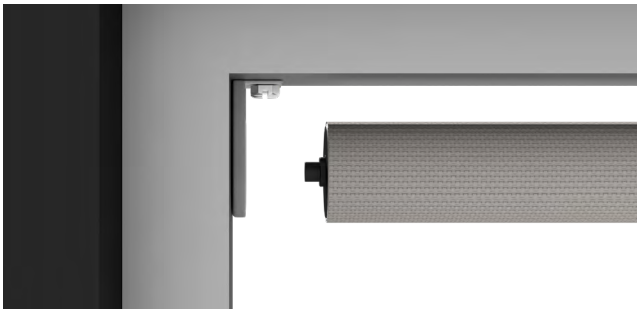

B

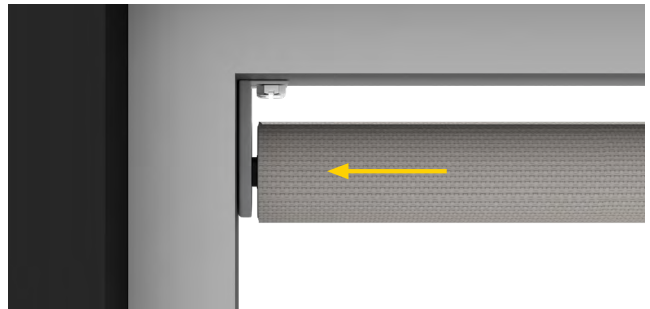

#### 5 CLUTCH END & TENSION DEVICE INSTALLATION

Lineup to clutch bracket. Push clutch into clutch bracket. Install tension device.

A.



B.



C.

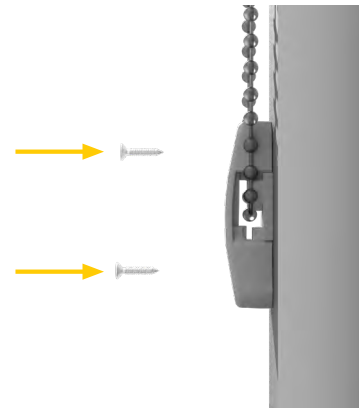

11 COMPLETED INSTALLATION

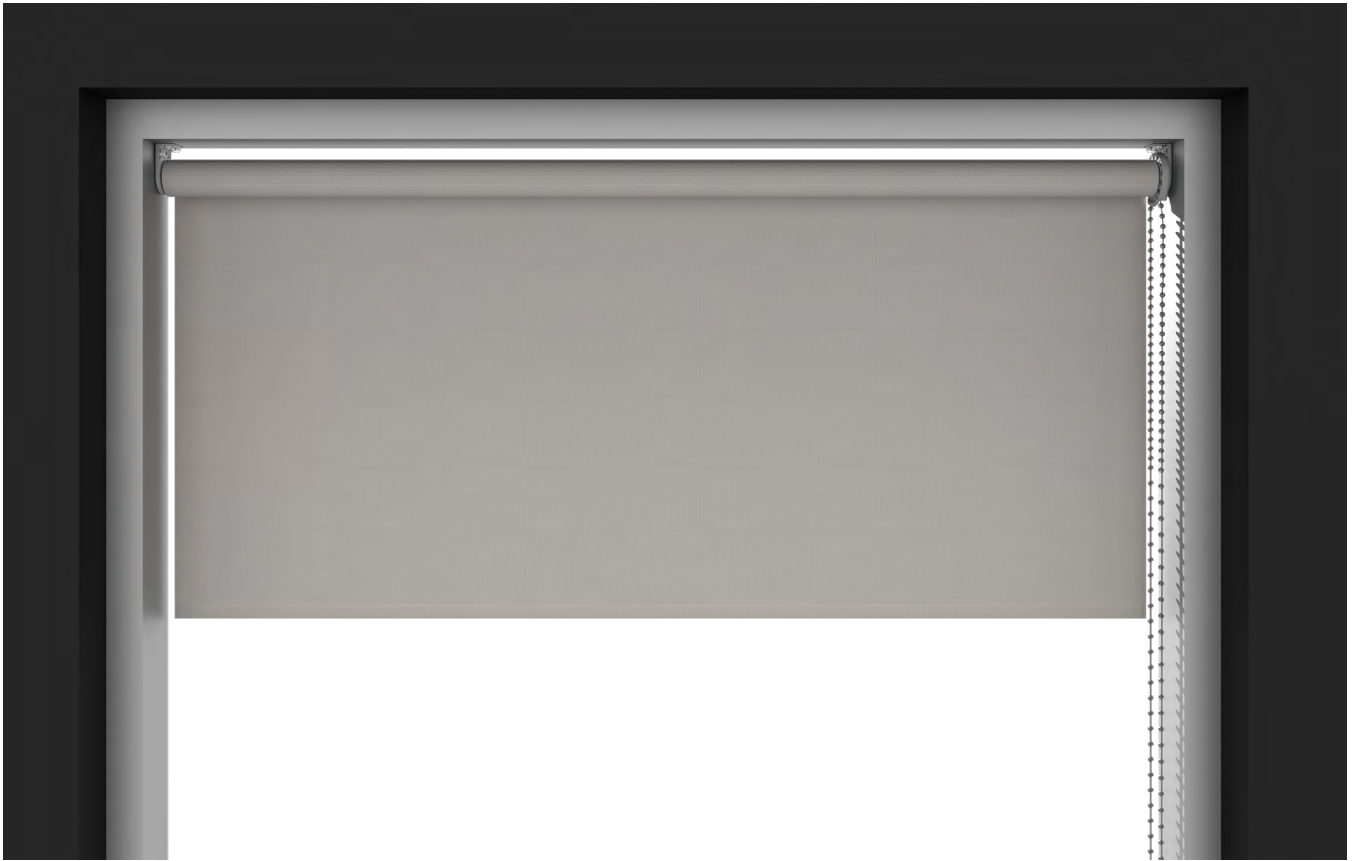









## OUTSIDE MOUNT & TENSION DEVICE INSTALLATION

With provided screws, install bracket first with large screws (use Chainhold marked screw hole locations as reference). Pull the Chainhold down until the chain is fully tensioned (plunger will be fully raised). Install Chainhold into bracket with small screws.

A

B

PULL CHAIN  
DOWN &  
MARK  
LOCATION

REMOVE  
TENSION  
DEVICE  
& DRILL

C

D

E

F

PLACE  
TENSION  
DEVICE ON  
BRACKET

SECURE  
TENSION  
DEVICE

**NOTE:** Please make sure shade operates smoothly.