









RAS - Installation Instructions Plus+ Shade 4" Bottom Fascia Manual

Hardware Included				Tools Required	
					
Self Tapping Screws for Aluminum	Wood Screws (If requested)	Self Tapping Phillips Screws for Tension Device	Drywall Anchors	Bracket Cover (Optional)	1/4" Hex Head
					
		Metal Stop Ball	Brackets	Fascia	Phillips Head

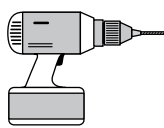
1. Install Bracket

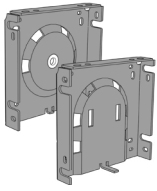
Attach the brackets to the window frame, molding, wall or ceiling. Brackets are directional oriented, control side has indents for clutch and in end bracket has a small hole for pin end. (picture shows a right control install). Indents in sides can be used for easier access when screwing from the side. Two screws must be installed in each bracket.

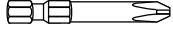
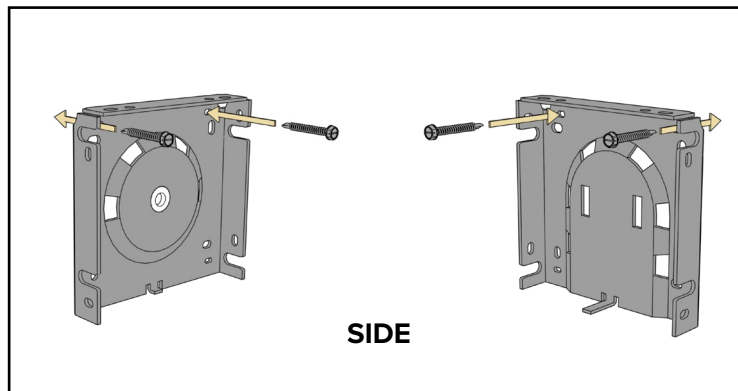
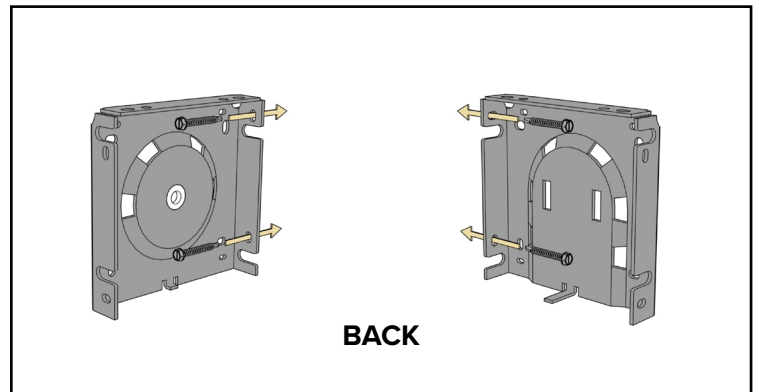
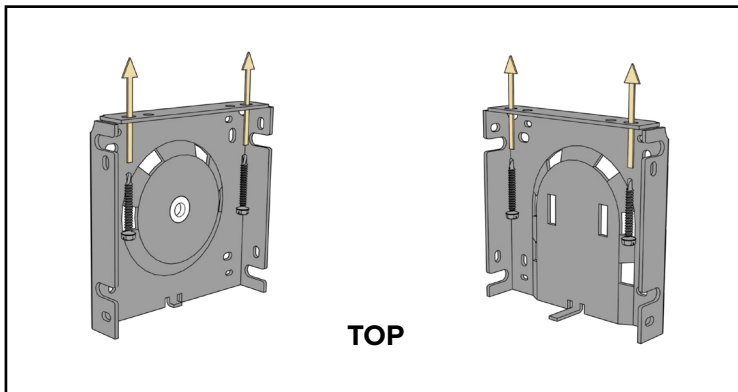

2. Install Shade

Push the clutch straight into the indents in the bracket. The bottom of the clutch should always point straight down (Fig A). Next, using your finger or a flat end screwdriver, press in the pin end, keeping it compressed (Fig B) while maneuvering it into the hole in the pin end bracket (Fig C).

Note: If you need to remove the shade, compress the pin end by using a flat end screwdriver and pull the shade down and out.

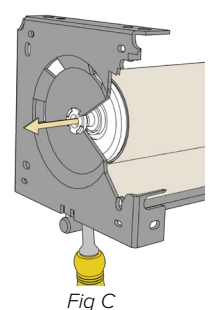
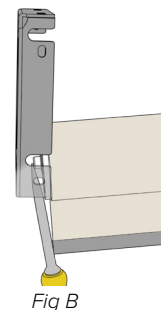
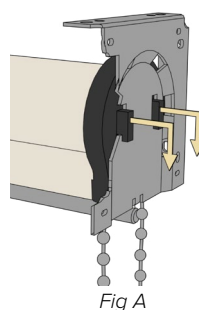

3. Shade Adjustment (If Necessary)

Roll shade up and down to confirm bottom rail is level and material rolls up straight on center tube. If the bottom rail is not level, lower shade until metal tube is visible. Add layers of masking tape to the metal tube to the end that is too low until bottom of rail is straight. If the material tracks to one side, lower shade until metal tube is visible. Add layers of masking tape to the metal tube to the end that is opposite the direction of tracking, until shade rolls up straight.

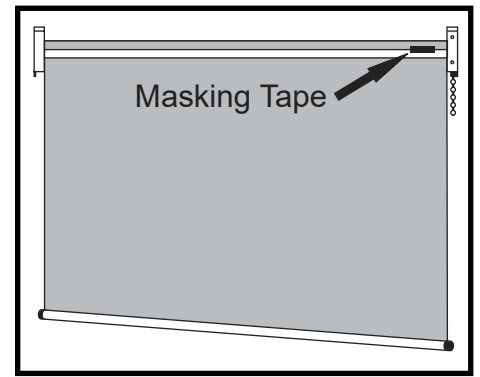

4. Installing the Fascia

Hook fascia to the top of the bracket and gently press fascia down to snap into bracket.

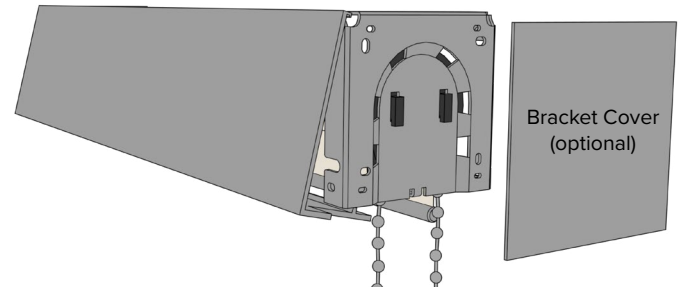

5. Installing Metal Stop Balls to Bead Chain

Pull the rear chain to lower the shade to appropriately 1/4" above sill and attach connector or stop ball to upper most bead on front chain closest to the clutch. By attaching this connector or stop ball you will set how far the shade will lower. Pull the front chain and raise the shade so the bottom rail is 5" below the shade and attach a connector or stop ball on the back chain at upper most bead.

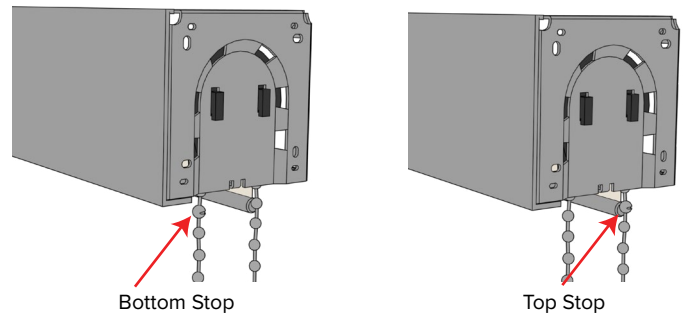

6. Install the Chain Anchor

The chain anchor is a plastic piece that is attached to the chain to secure it from possible accidents. Position the chain anchor on the window frame so that the chain anchor and chain do not interfere with raising or lowering the shade. The chain anchor should be installed without stretching or pulling down on the chain. Leave a little play through the chain anchor to allow the chain to pass freely. Do not twist or cross the bead chain. Secure the anchor with Phillips screws in both upper and lower holes.

Warning: Failure to use this device may cause injury or death

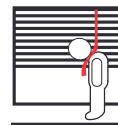
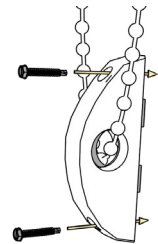

Window Blind Cord Can STRANGLE Your Child

- Children can climb furniture to reach cords
- Move cribs and other furniture away.
- Keep all cords out of children's reach.
- Attach tension device to wall or floor.
- Fasteners provided with the tension device may not be appropriate for all mounting surfaces.
- Use appropriate anchors for the mounting surface conditions.