

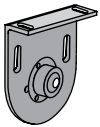

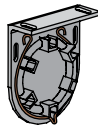

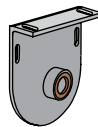

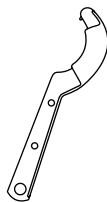

RAS - Installation Instructions Contract Plus+ Shade Open Roll Motorized Linked ZMC UL 

Hardware Included				Tools Supplied	Tools Required	
						
Double Bearing Pin End Bracket	Motor Bracket	Double Bearing Pin End Bracket	Drywall Anchors			Phillips Head
						
			Screws			
						
Wall Switch	Switch Box	Wire Tie Pads	#14 Screw			
						
			Zip Ties			

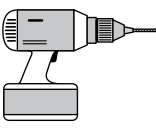
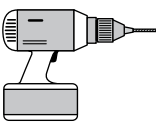
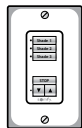
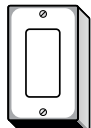
1. Install Bracket

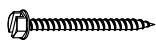
Install brackets into drywall per measure sheet diagrams (1a) and (1b). Drywall should have adequate substrate beneath, or use supplied drywall anchors.

****Note: All shades are programmed to sensor or wall switch, upper/lower limits need set.****

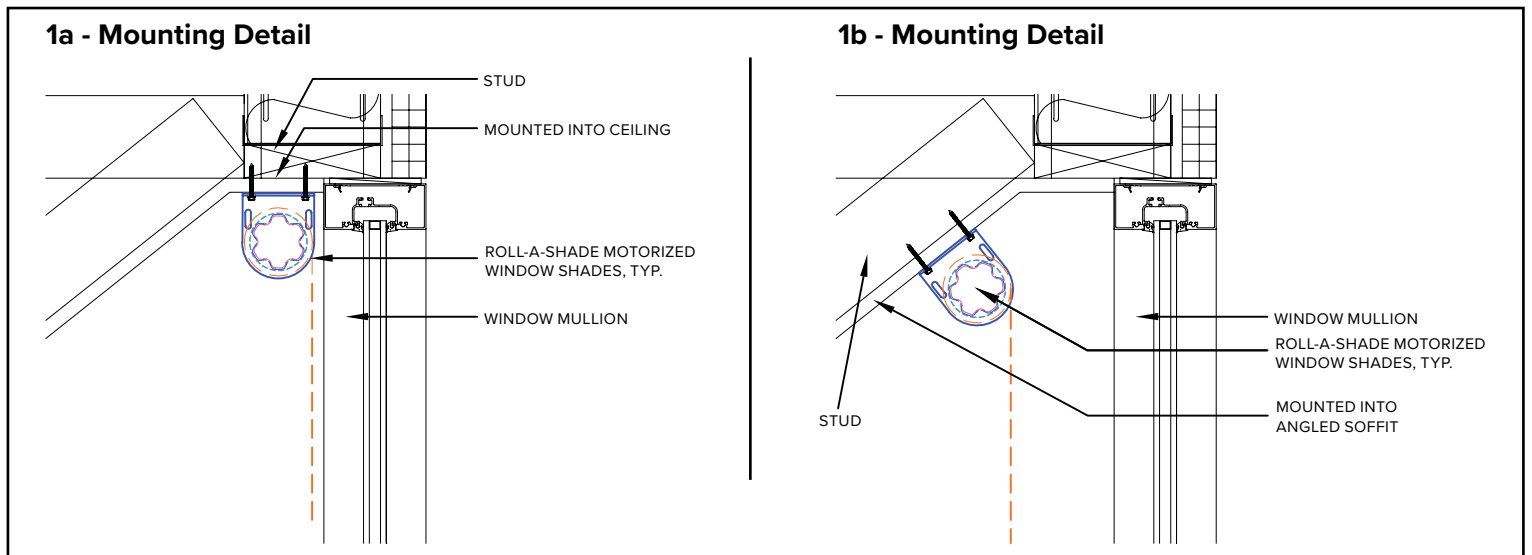

2. Install Brackets

Attach the motor bracket to the wall or ceiling per (2a) or (2b). Then attach the link bracket. If link brackets are not used in this configuration, attach the pin end bracket.

Note1: Brackets may be rotated for side mount.

Note2: If screws do not secure into stud, use supplied dry wall anchors.

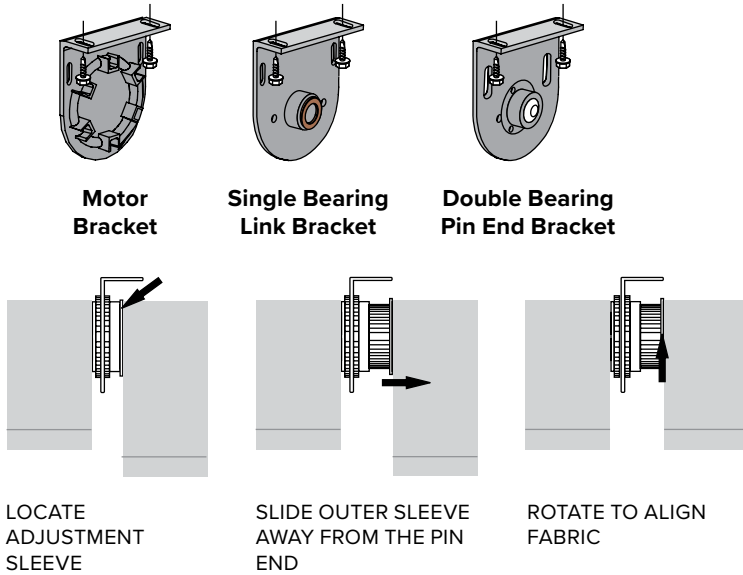

5. Install additional Linked Shades

Install link bracket per detail (E). Insert motor side of shade into bracket locking with previous shades. Rotate pin end/link to screw in pin (F). Insert pin into bracket and release pin (G).

****Note: Align shades to motor shade as you go.****

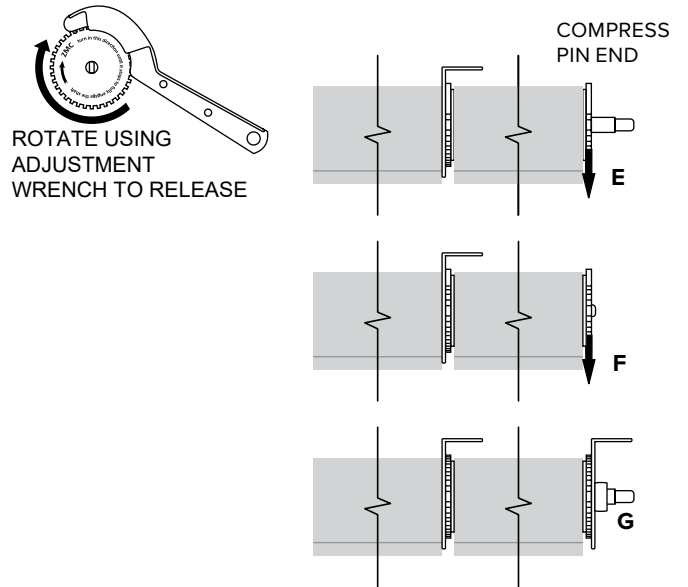

4. Install the Motorized Shades

Insert the star end of the motor into the bracket (A). Rotate pin-end/link to screw in pin (B). Insert pin into bracket and release pin (C). Slide the locking ring up thru the grooves of the motor bracket and motor (D).

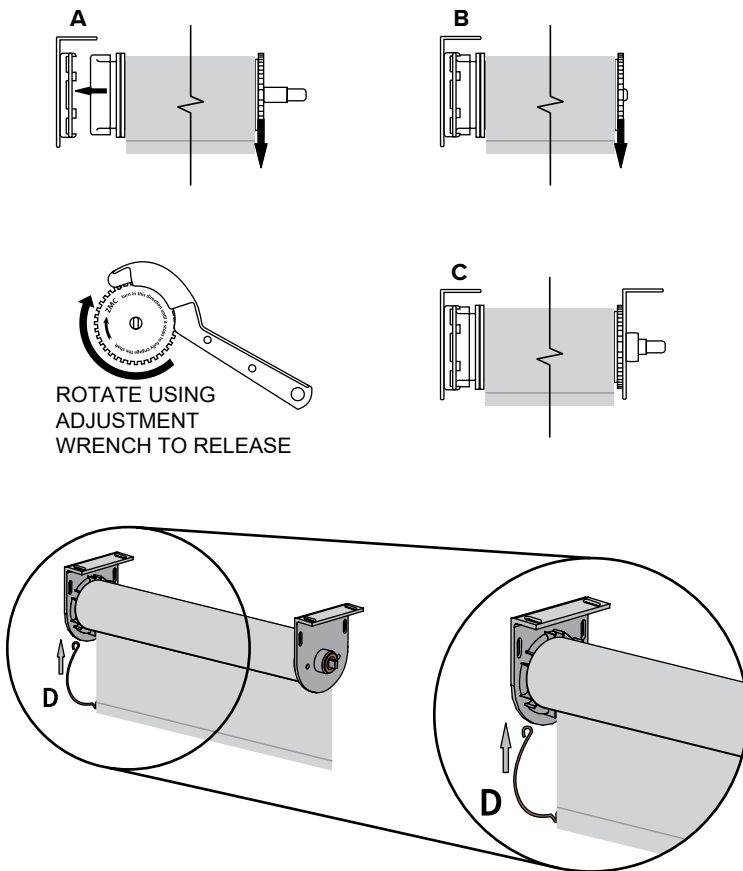

6. Shade Adjusting (If Necessary)

- Roll shade up and down to confirm hembar is level and material rolls up straight on center tube.
- If the hembar is not level, lower shade until you see the metal tube.
- Add layers of masking tape to the metal tube to the end that is too low until hembar is straight.
- If the material tracks to one side, lower shade until you see the metal tube.
- Add layers of masking tape to the metal tube to the end that is opposite the direction of tracking, until shade rolls up straight.

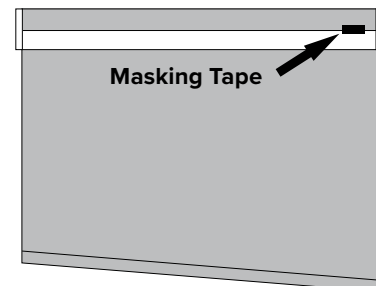

7. Install Pin End Shade (Linked System)

Before hanging last shade, retract the linked idler end (H). Insert pin into last bracket (I). Release idler pin of linked shade (J).

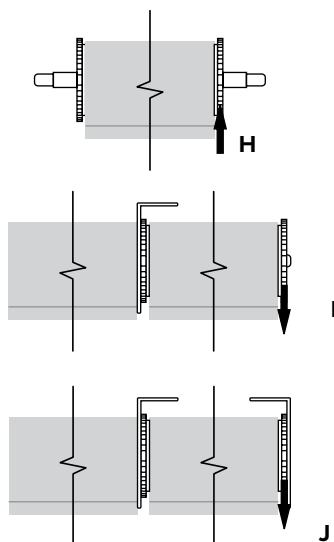
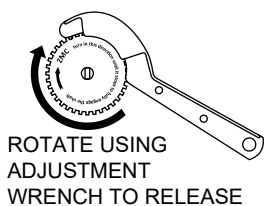

8. Plug in Motor

- Run motor power cord to nearest power outlet.
- Install wire tie pads and secure with zip ties to hold wire down.
- The path of the wire should be parallel with mullions and/or drop ceiling tiles ensuring the cable is neatly organized.
- **Note1: If using same outlet for multiple motors, the plug may need to be rotated by loosening the middle screw of the plug and rotate to desired position.**
- Then, tighten screw.
- **Note2: If you need to shorten the power cord, loosen cord clamp screws.**
- Loosen face screw and separate units.
- Do not remove screws.
- Cut cord to desired length.
- Prepare cord by removing the outer jacket 1 5/8".
- Strip bare each conductor 3/8" strands.
- Connect green (ground) wire under terminal clamp with green screw.
- Connect white (neutral) wire under terminal clamp with silver screw, and black (hot) wire under terminal with brass screw.
- Reassemble device by aligning to desired position.
- Tighten face screw.
- Tighten cord clamp securely, making sure that cord jacket is being clamped uniformly while securing clamp.
- **WARNING:** Failure to wire as instructed may cause personal injury or damage to device or equipment.

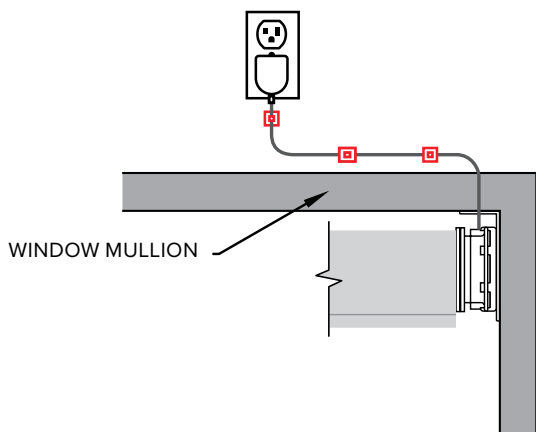

Adjusting Limits

Re-adjust Upper Limit (UP Shade Position)

1. Press the UP directional button on the transmitter. Shade will travel to the pre-set UP limit.
2. **Once shade stops at pre-set up limit**, press and hold the UP and DOWN buttons simultaneously on the transmitter until the shade jogs.

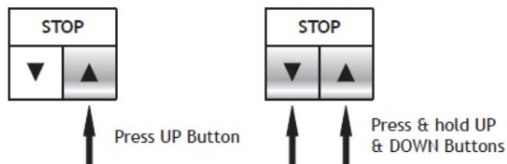

3. Press and hold either the UP or DOWN button on the transmitter to adjust shade to new position.
4. Press and hold the STOP button until the shade jogs. New Upper Limit (Up stop position) is now added to memory.

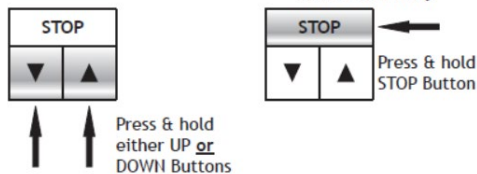

Re-adjust Lower Limit (DOWN Shade Position)

1. Press the DOWN directional button on the transmitter. Shade will travel to the pre-set DOWN limit.
2. **Once shade stops at pre-set down limit**, press and hold the UP and DOWN buttons simultaneously on the transmitter until the shade jogs.

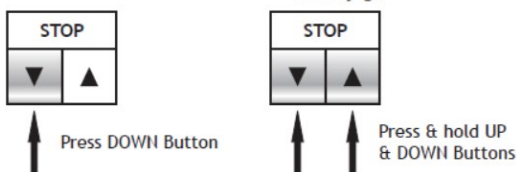

3. Press and hold either the UP or DOWN button on the transmitter to adjust shade to new position.
4. Press and hold the STOP button until the shade jogs. New lower limit (Down stop position) is now added to memory.

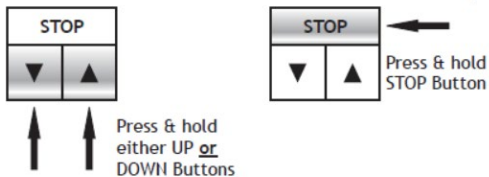

Switch Box Installation

Install switch box under cash register closest to the entrance doors. Install on cashier's side.

Note: DO NOT INSTALL ON FRONT OF REGISTERS

