



RAS - Installation Instructions for Barrier Shade System

Hardware Included			Tools Required
			
Self Tapping Screws for Aluminum	Cording x2		
			
Wood Screws (If Requested)	Adjustable Cord Locks x2		
			Drill

1. Choose Installation Process

Install your Barrier Shade by using the the **(1A)** aluminum screws or **(1B)** drop ceiling clips, cording and adjustable cord locks depending on your ceiling format.

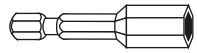
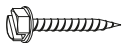
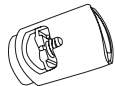
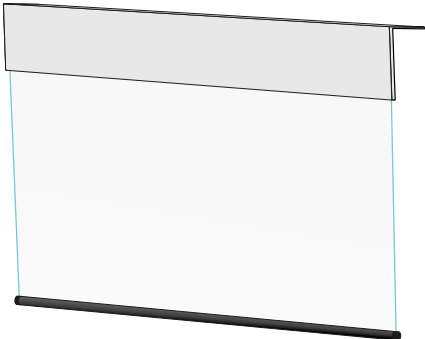
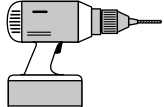
NOTE: If your installation process is (1A) you no longer need to proceed further in the instructions.

1A

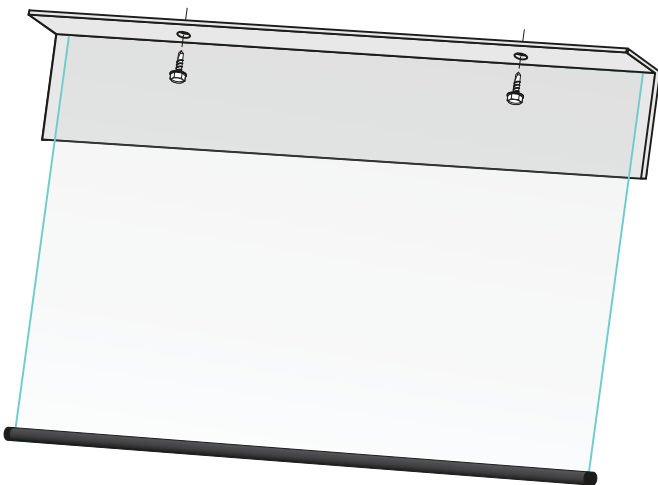

1B

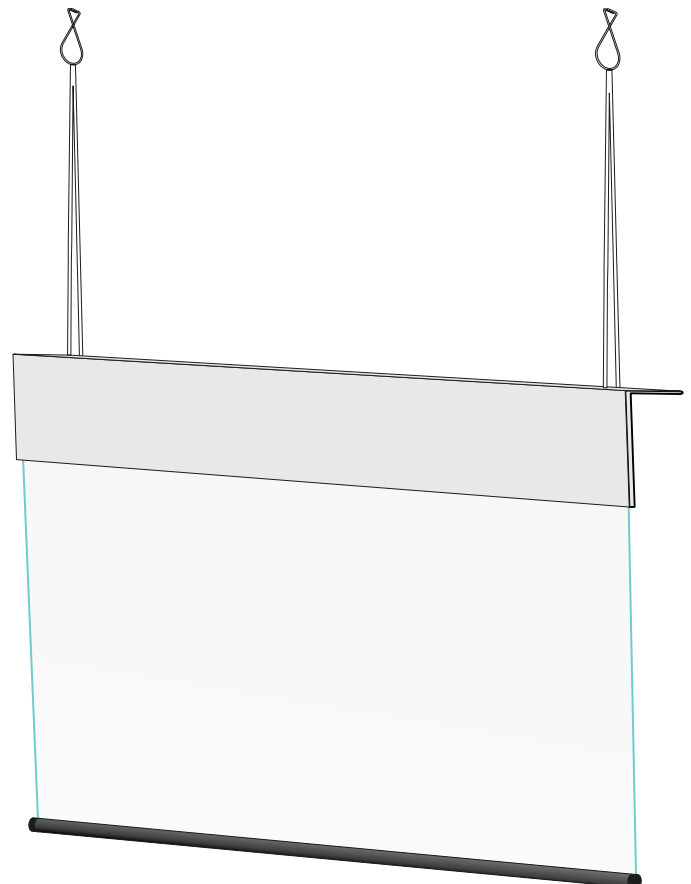

2. Adjustable Cord Lock & Cord Preparation

Undo Cord lock from cord. Slip cord through metal bracket holes. Do the same for the other side.

NOTE: You should only be proceeding to this step if you need to install your Barrier Shade into a drop ceiling.

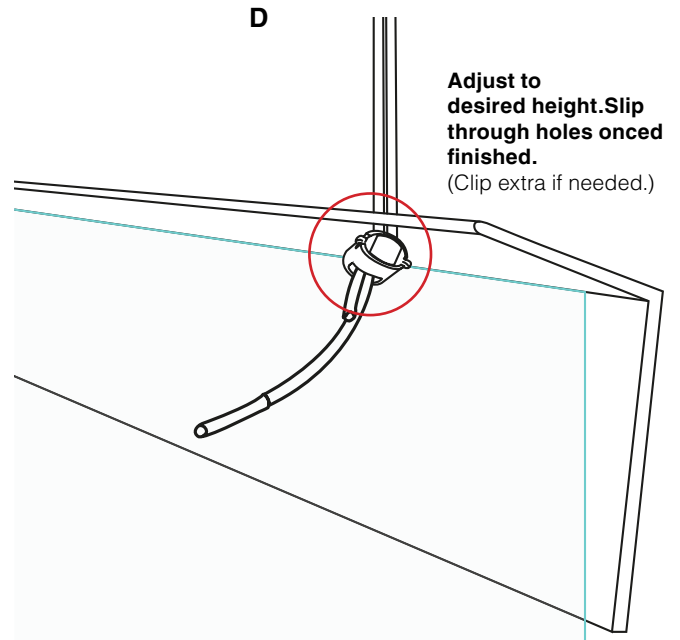
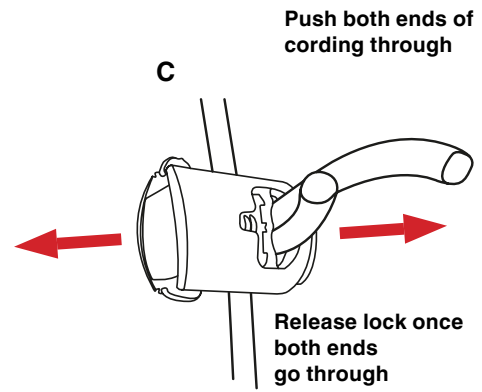
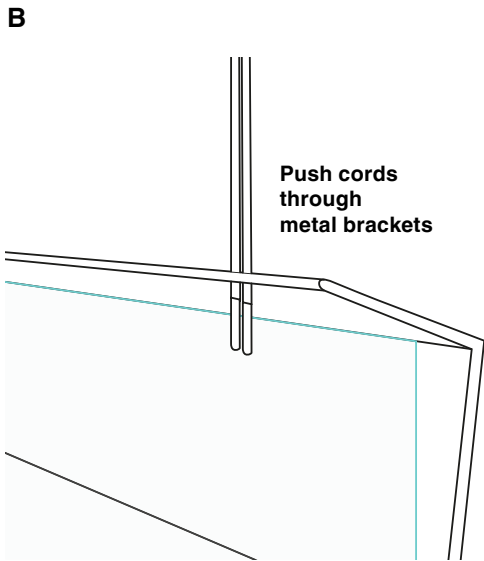
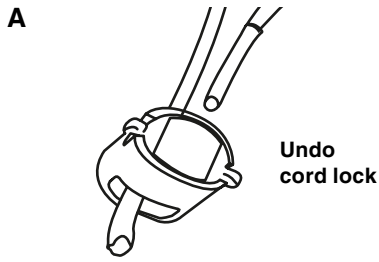

3. Install Adjustable Cord Lock

Install the adjustable cord locks on both ends of the cords by pressing the lock and inserting both ends through the hole. Release lock once both ends of the cords have gone through. Adjust lock and desired height.

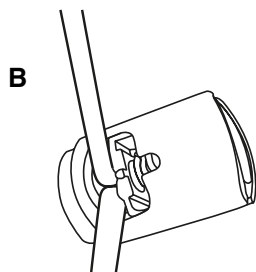
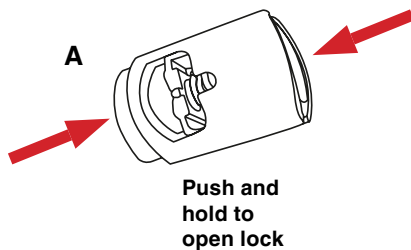

4. Drop Ceiling Install Preparation

First step to installing your Barrier Shade is to loop one of the cords trough the drop ceiling clip. You must do the same for the other drop ceiling clip and cord.

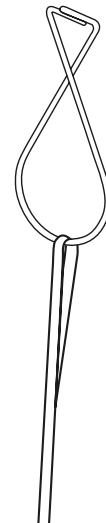

5. Install Drop Ceiling Clips Into Ceiling

Once both sides of the Barrier Shade and drop ceiling clips are looped and locked in with the adjustable cord locks. Install your drop ceiling clips by pressing each side of the loop to clip into the drop ceiling brackets.

NOTE: You must install both ceiling clips into the ceiling at the same time if possible.



(An example of a drop ceiling)

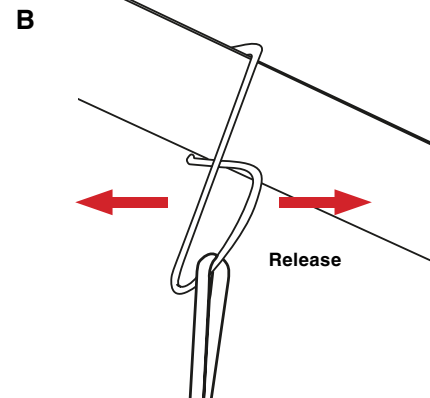
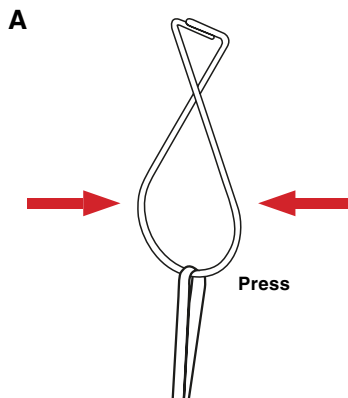

6. Installation Complete

Below is a visual of the complete product once installed into drop ceiling.

